



Lestrarbók með
dagagestum



© Setrið í
Sunnulækjarskóla



Höfundur
Kristín Björk Jóhannsdóttir



Bókin um
B og Ð
Lestur







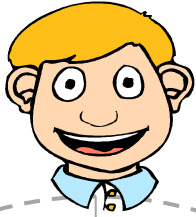

Nafn: _____





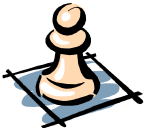
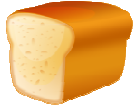

Hæ og hó

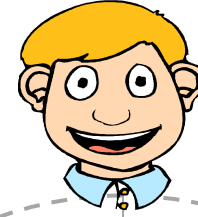

 bað	 bátur
 ber	 bók
 bjalla	 búð
 peð	 brauð

Hæ og hó



að	 baka
lagið	 borða
það	með
 hljóð	sagði



Þetta

er

lagið

hans

Fúsa.



Hvaða **hljóð** er þetta?



Þetta er skóla- **lagið**.

Þetta er skóla- **bjalla**.

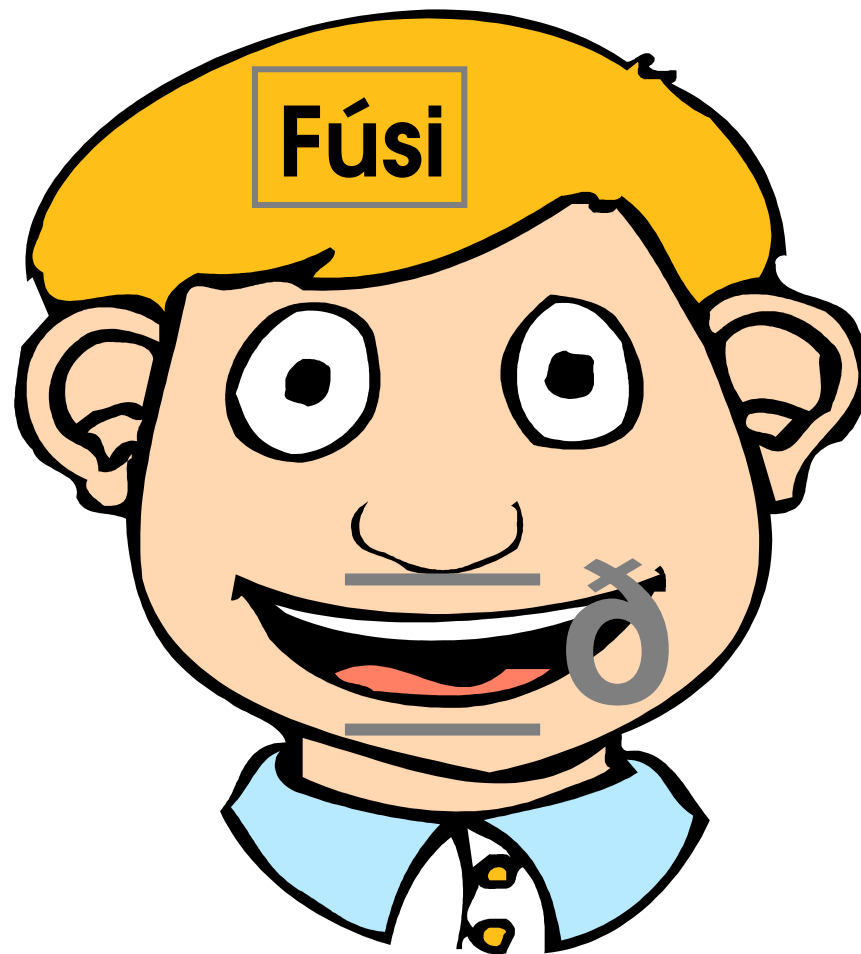

Fúsi

er

með

bók

um

B

og

ð.

baka
borða

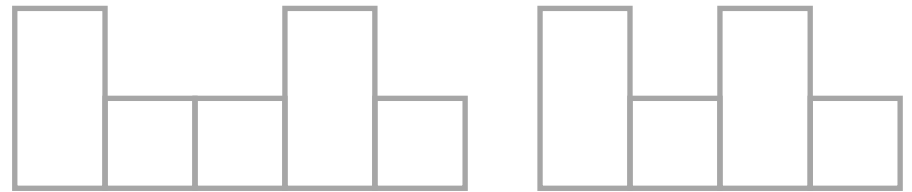

Ég vil **brauð**, sagði Fúsi.



Ég vil **baka** brauð, sagði Fúsi.

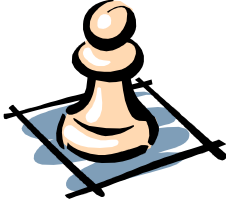

Ég vil **borða** brauð, sagði Fúsi.

petta er 

pað er hér.

bú → đ  búđ

bó → k  bók



petta er ber.



Fúsi sagði b, b, b.

pað er hér.

Fúsi sagði ð, ð, ð.

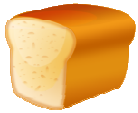

petta er brauð.



Fúsi á bað.

pað er hér.



Fúsi er í baði.

ba → đ



bát → ur

bađ

bátur

Hér er

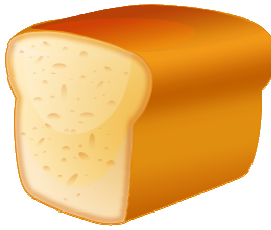
Hér er

Bók á b.



Bátur á b.



Búð á b og ð.



Bað á b og ð



Hér er bók.



Hér er bátur.



Hér er búð



Hér er bað

u
ó
á
þ
í
ú
æ
o

Leiðbeiningar: Orðahjól

1. Hjólin eru klippt út.
2. Einn þríhyrningur er klipptur í burtu.
3. Fest á hjólið á innsíðu með splitti.
4. Hjólinu snúið og orðið í eyðunni lesið.



Leiðbeiningar: Stafarenningar

1. Stafarenningar eru klipttir út.
2. Skorið/klippt í línur á bls 1.
3. Renningar þræddir í og tenging hljóða æfð

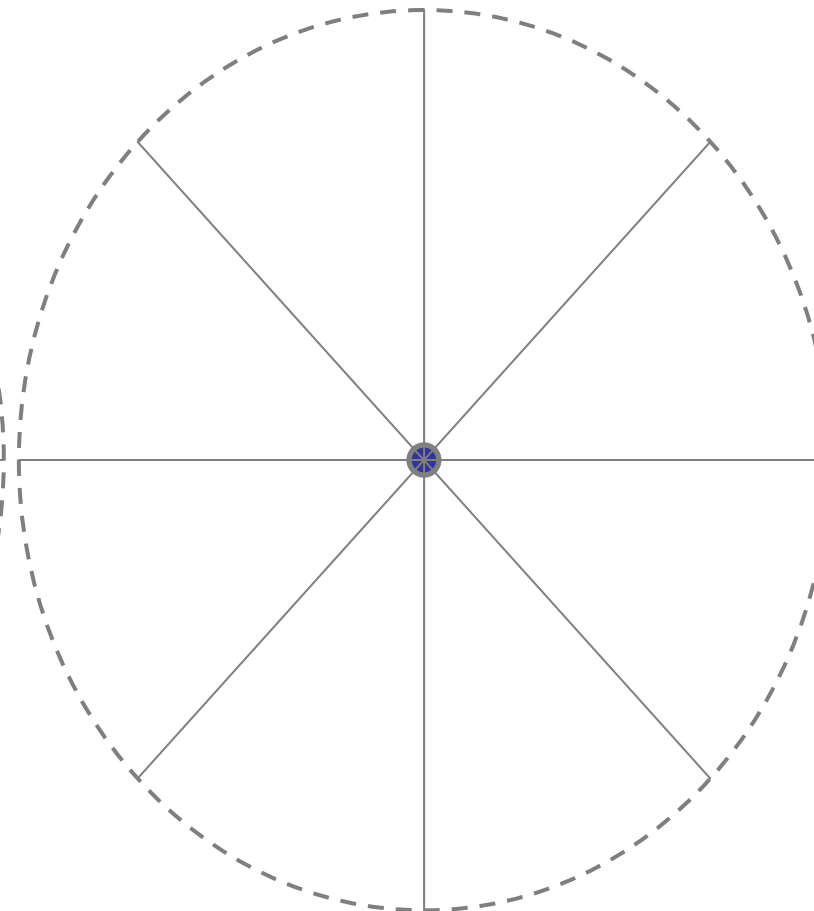
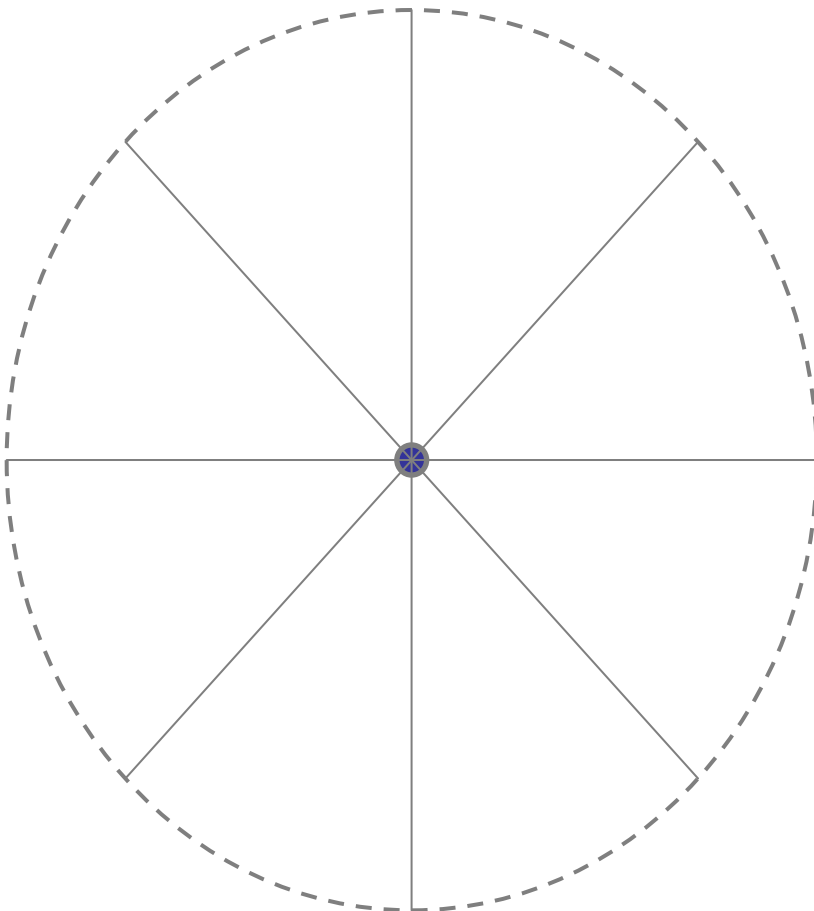

a
i
y
ey
ö
ý
ei
au



Leiðbeiningar: myndir í kassa

1. Myndir klipptar út.
2. Líma á myndirnar í reiti á bls. 3 og 4.

